

Carton Water 33 cl  
Sticker label 1 side

Sticker label 2 sides

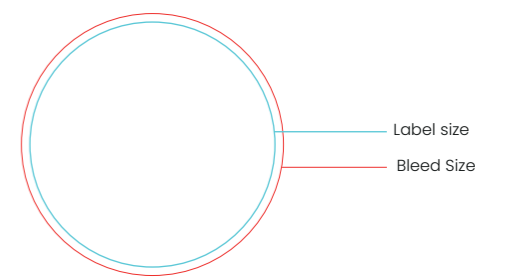
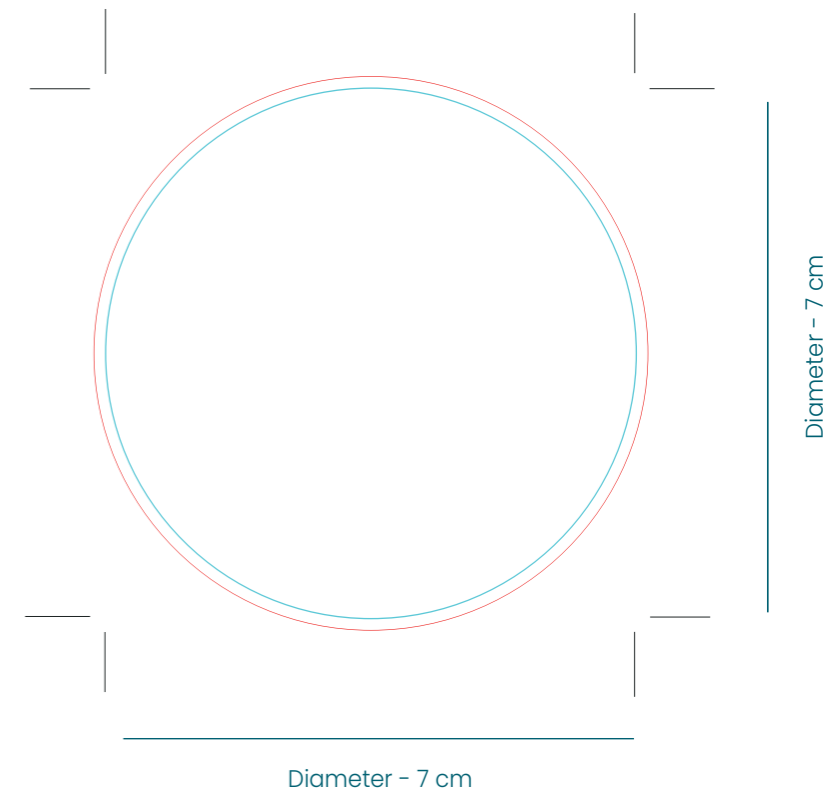
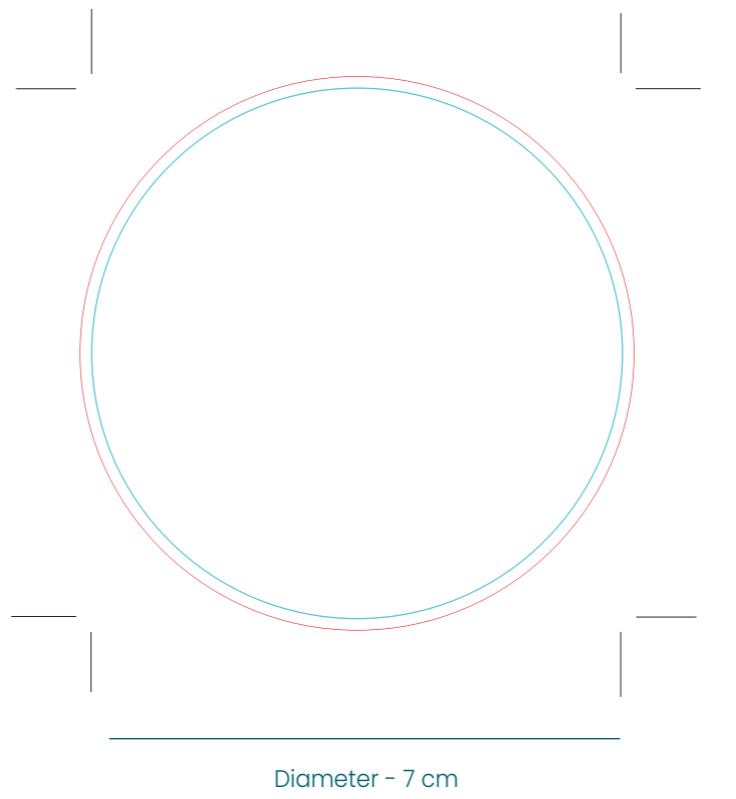
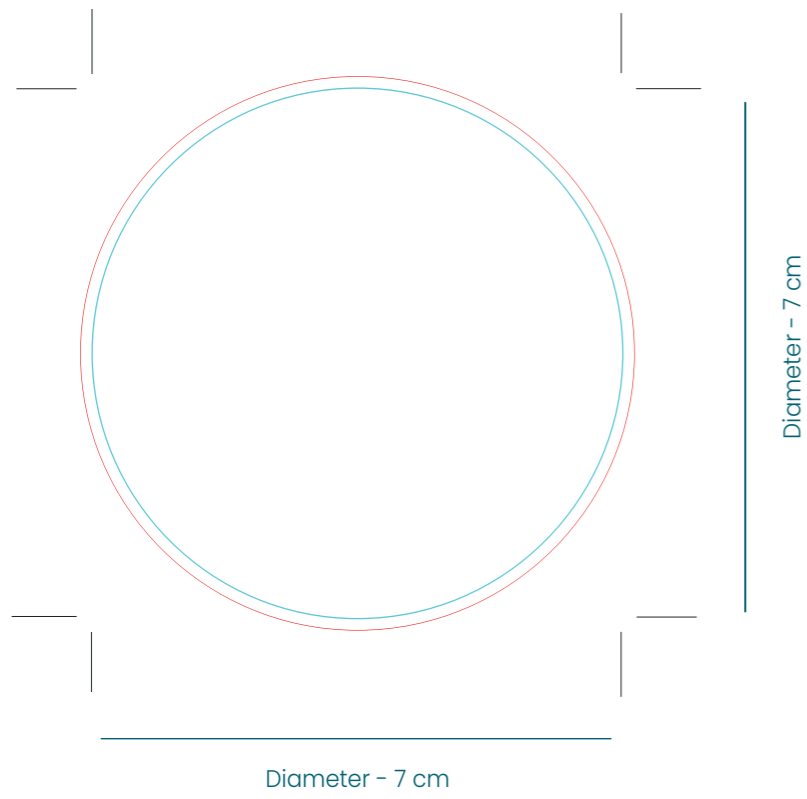

160

2 - 7

Carton Water 33 cl y 50 cl - Direct printing

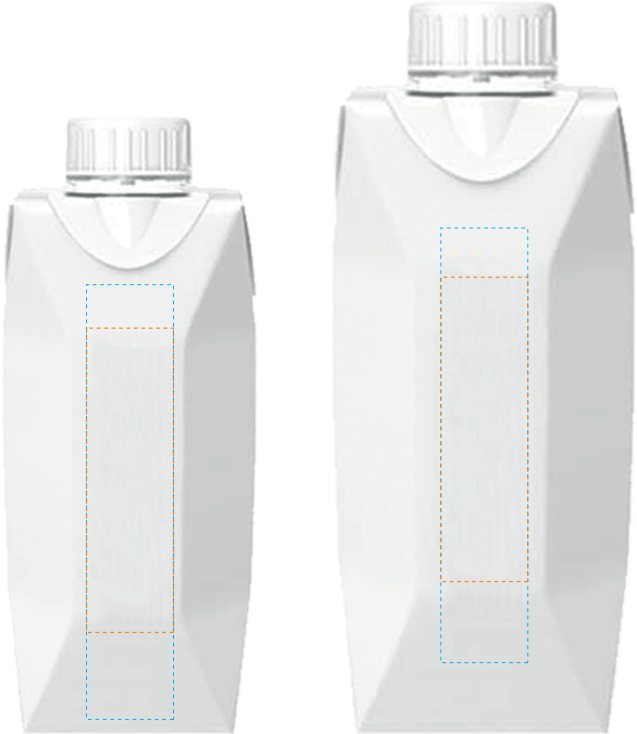

Printing area  
33 cl

Printing area  
50 cl

Printing area  
full-color

Printing area  
1 color

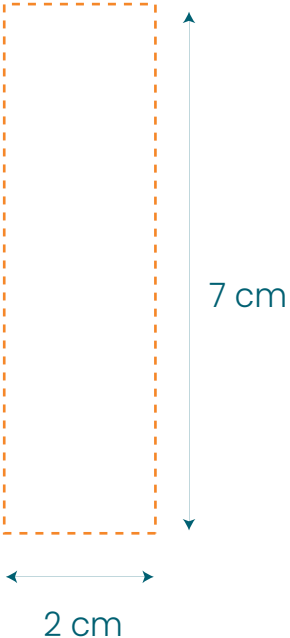
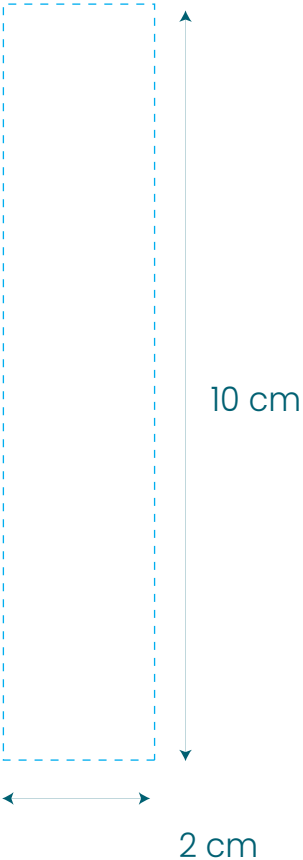

Carton Water 33 cl - Water ECO - Full color

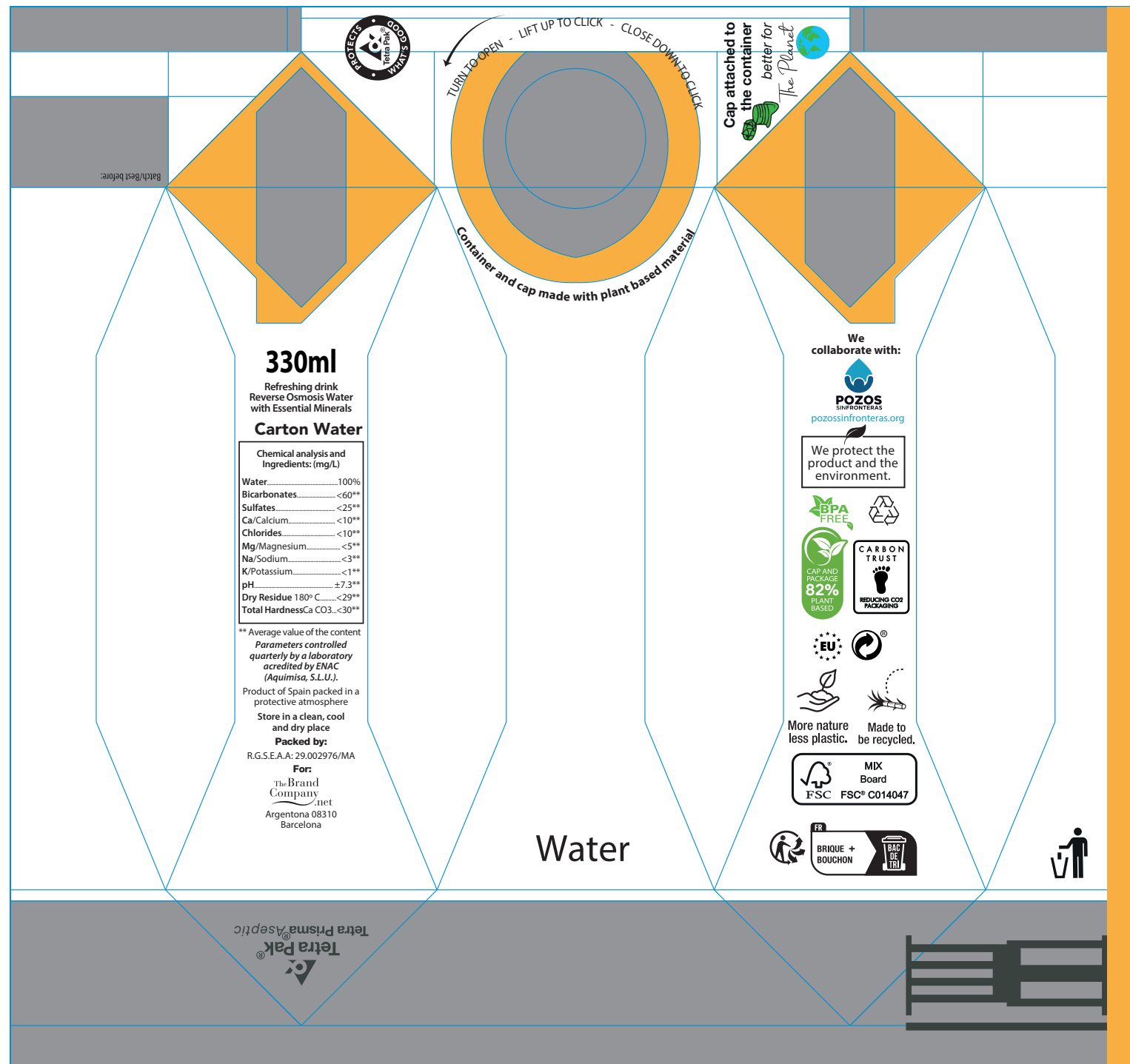

REMEMBER:

We will need 2 design files:

1. Open with all the images in LAYER. Attach the FONTS that are used in development (All editable), that are used in development (All editable).
2. Another file, vectorized.
3. Please keep the "KEYLINES" LAYER how you receive it.
  - You can change the placement and color / size of the texts as long as they have a minimum size of 7pt.
  - If you are going to make a background with a photograph or a plot, the letters in white should have a frame or profile around. We can do that for you.
  - The logos are optional (except the logos: recycled, FSC and tetra pack). They can be put in B / W or not.
  - The seal of collaboration with Pozos sin Fronteras (Wells without Borders) is optional.
  - You could add a phrase such as the one suggested here "We collaborate with" or add another of your choice.
4. Remove the Triman logo if you are not going to France

Carton Water 50 cl

Sticker label 1 side

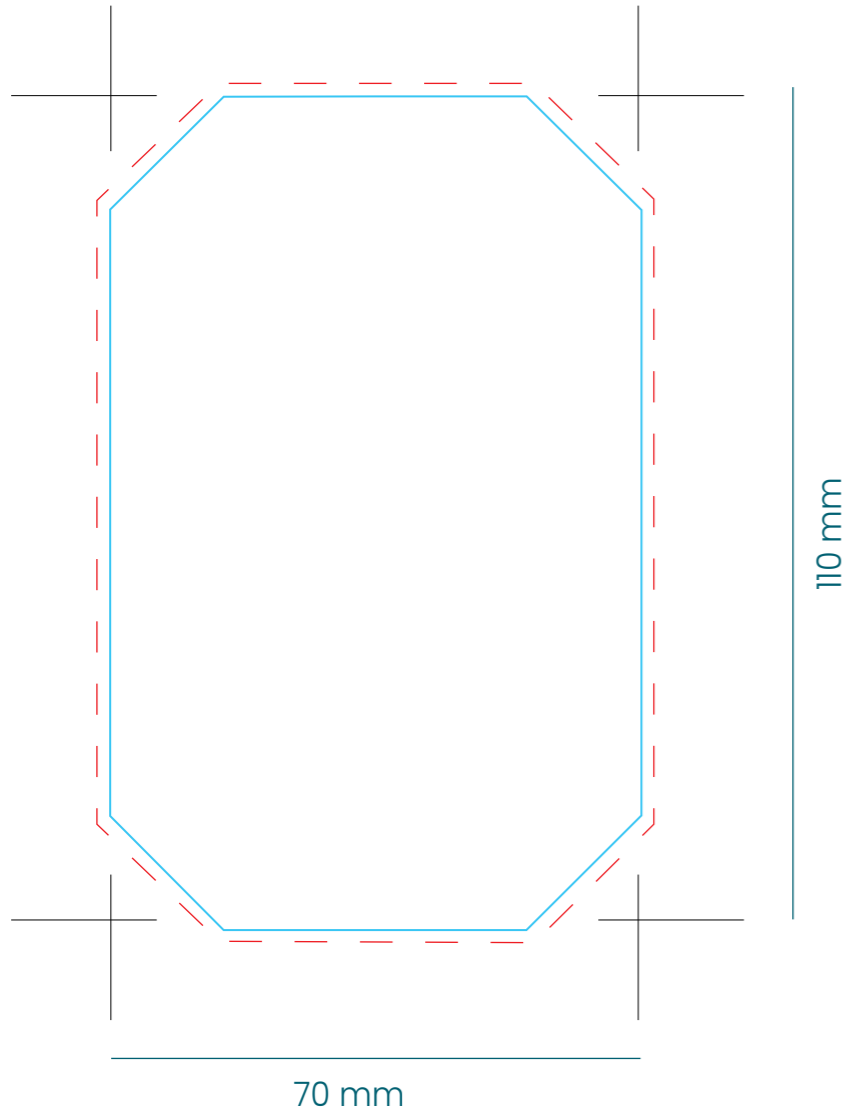

Sticker label 2 sides

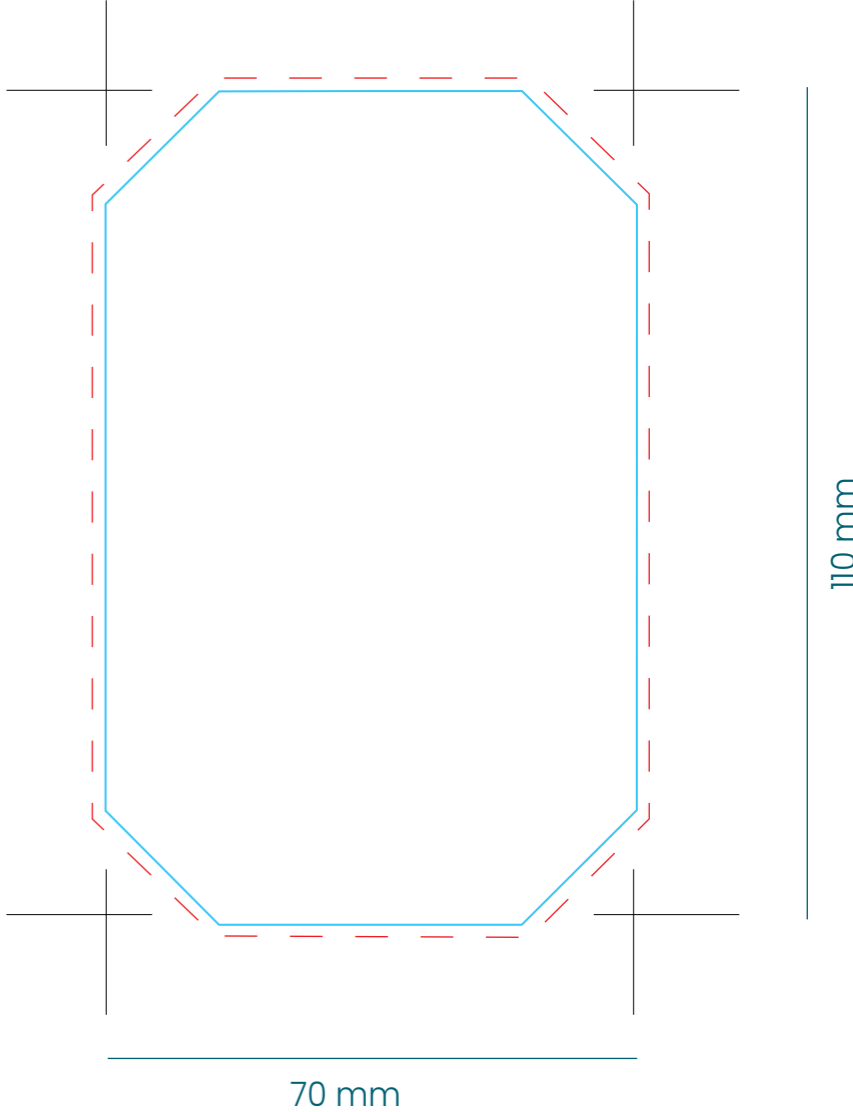
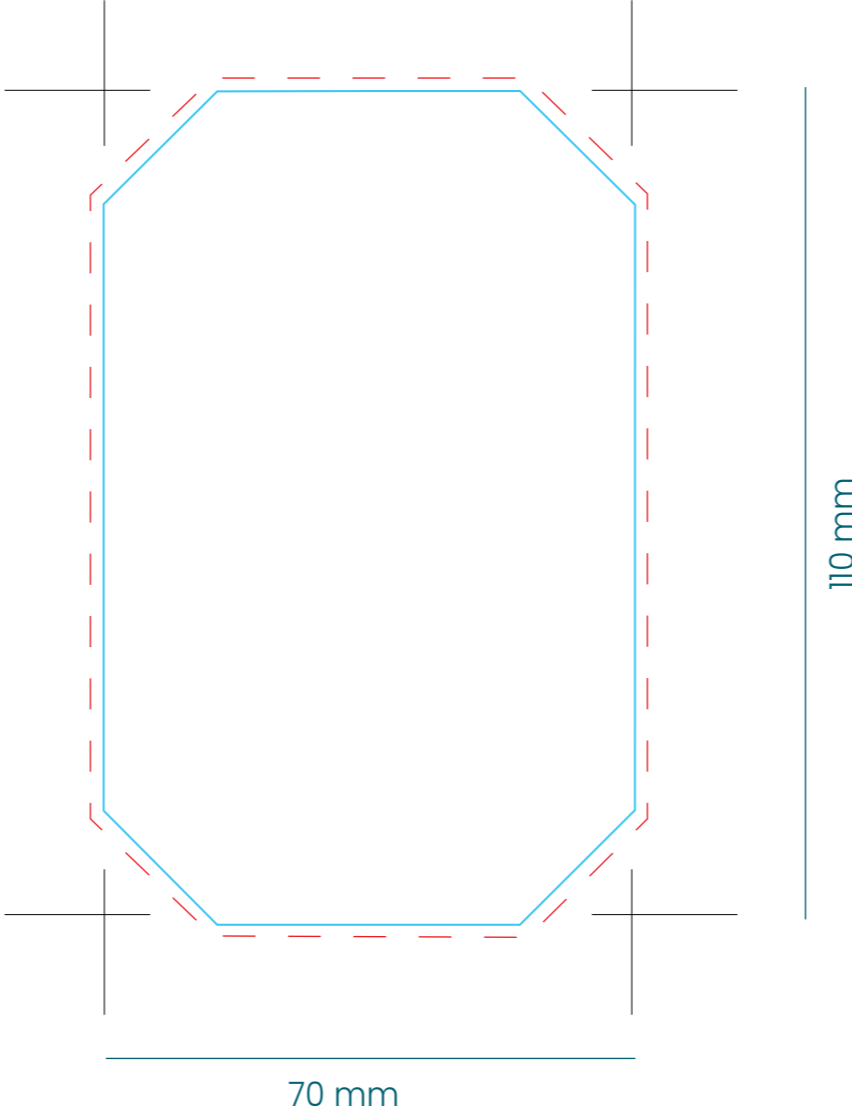

--- Dashed line bleed area

Brick of water 50cl - Full color

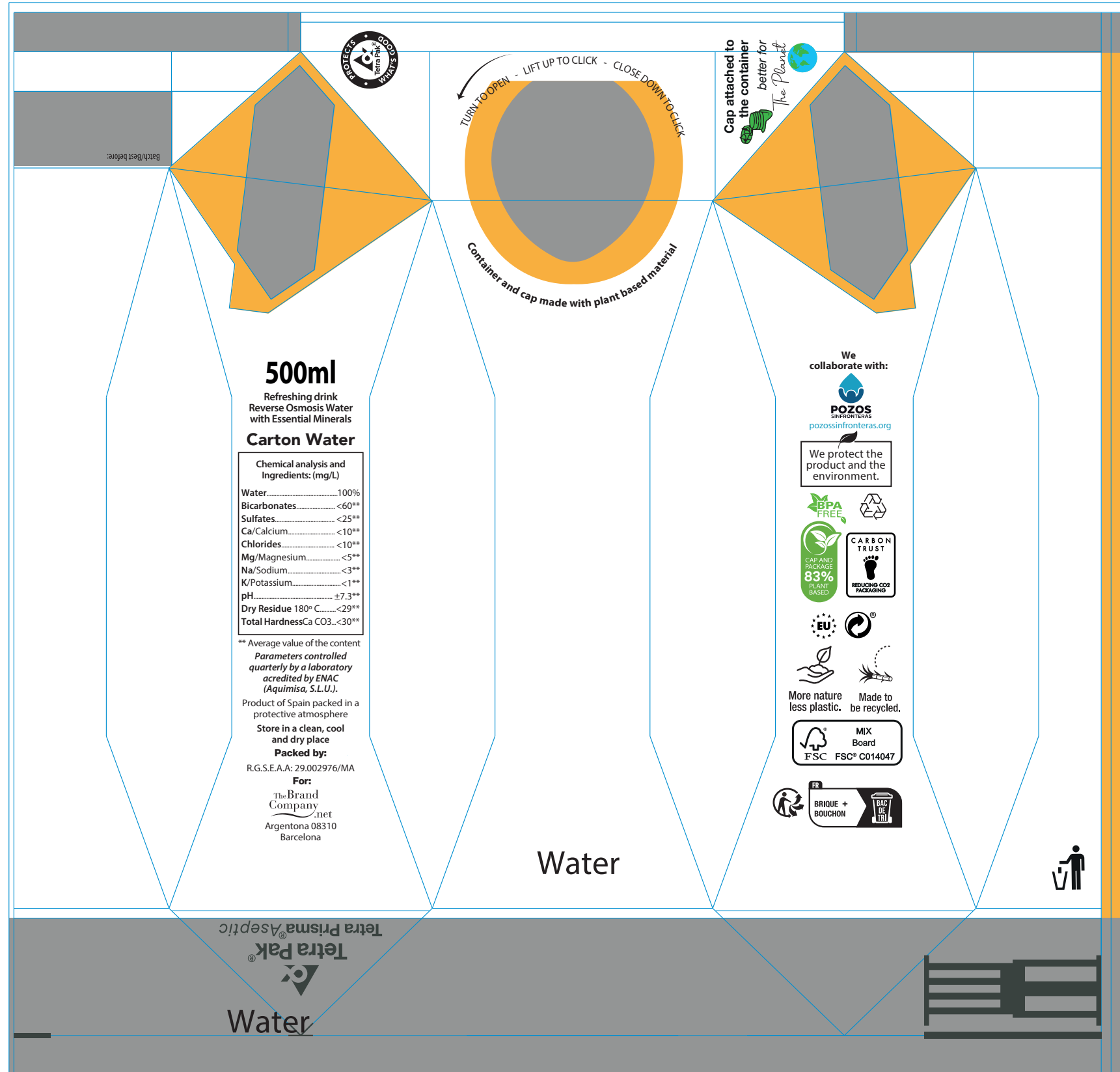

**REMEMBER:**

We will need 2 design files:

1. Open with all the images in LAYER. Attach the FONTS that are used in development (All editable), that are used in development (All editable).
2. Another file, vectorized.
3. Please keep the "KEYLINES" LAYER how you receive it.
  - You can change the placement and color / size of the texts as long as they have a minimum size of 7pt.
  - If you are going to make a background with a photograph or a plot, the letters in white should have a frame or profile around. We can do that us for you.
  - The logos are optional (except the logos: recycled, FSC and tetra pack). They can be put in B / W or not.
  - The seal of collaboration with Pozos sin Fronteras (Wells without Borders) is optional.
  - You could add a phrase such as the one suggested here "We collaborate with" or add another of your choice.
4. Remove the Triman logo if you are not going to France

Carton Water 1 litro

Sticker label 1 side

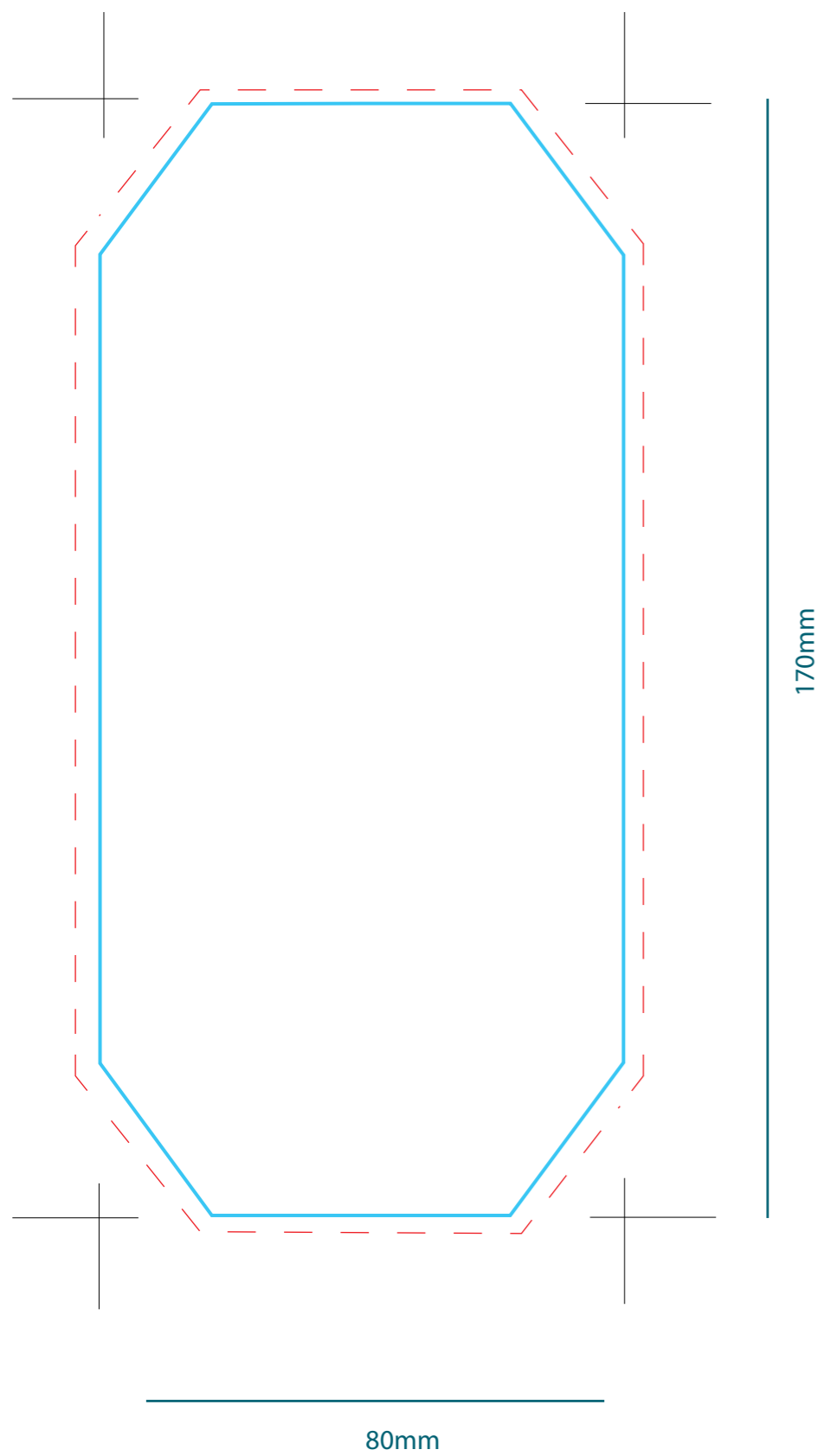

Sticker label 2 sides

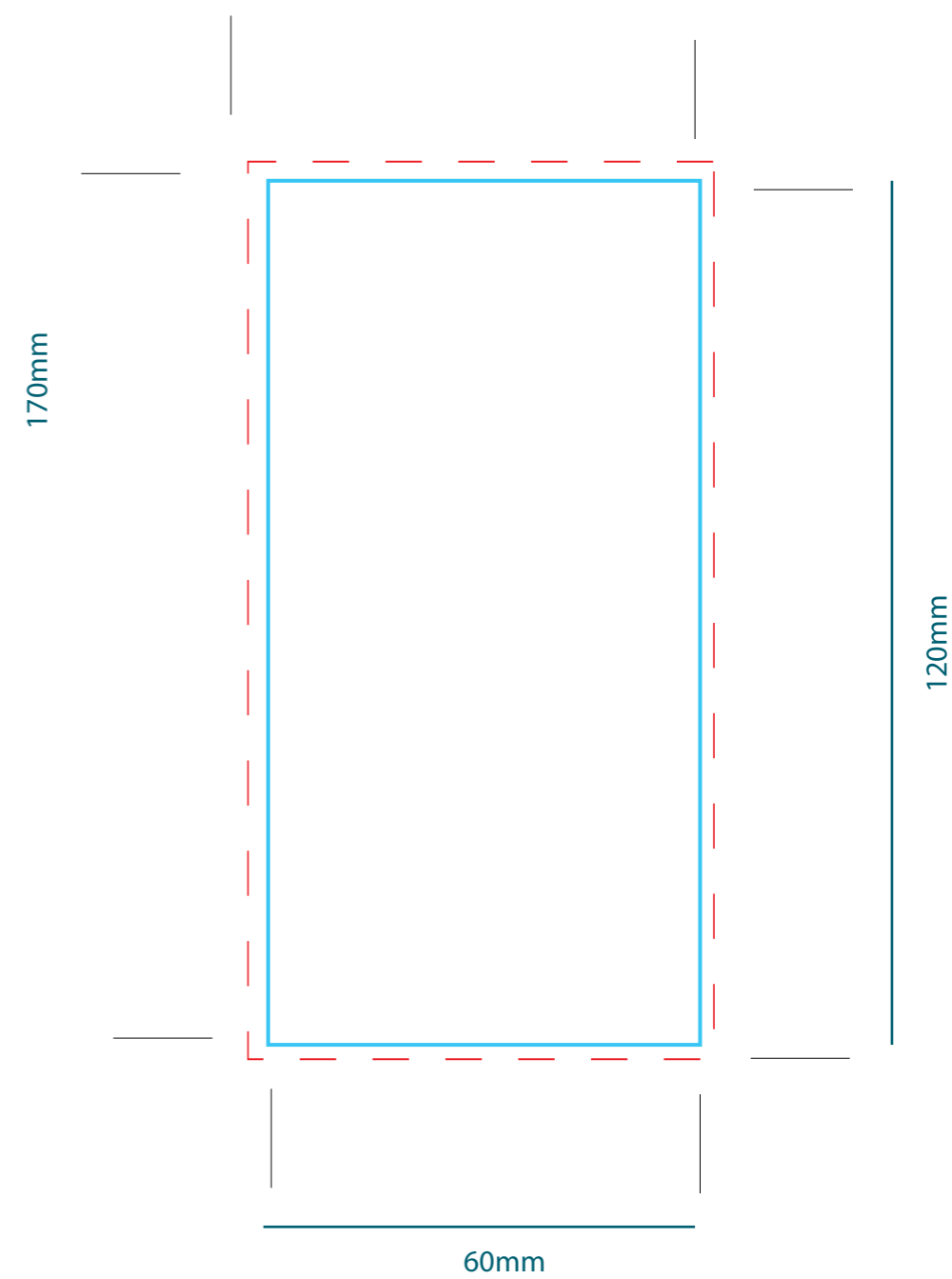
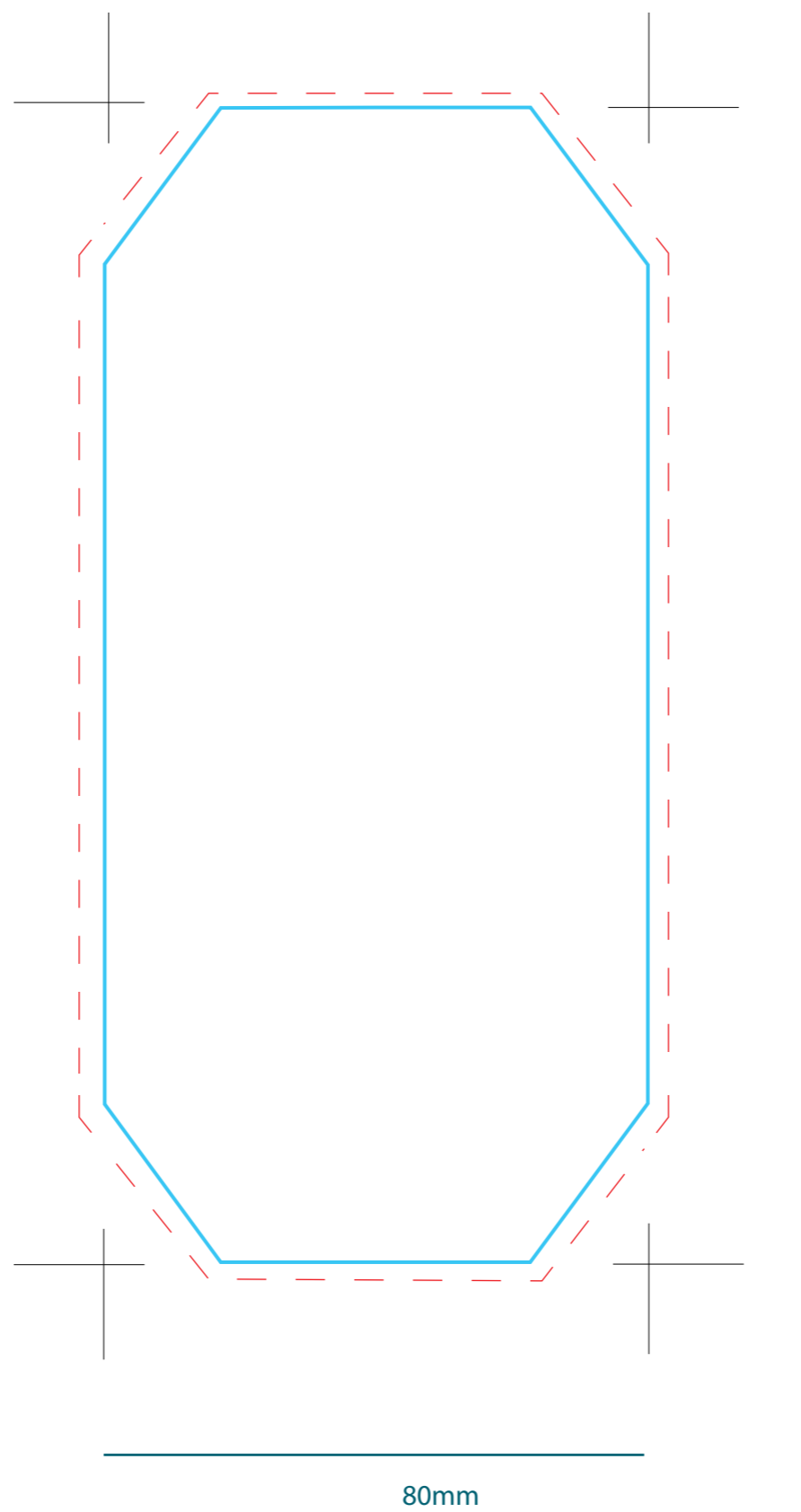

--- Dashed line bleed area

## Brick of water 1 litre - Full color

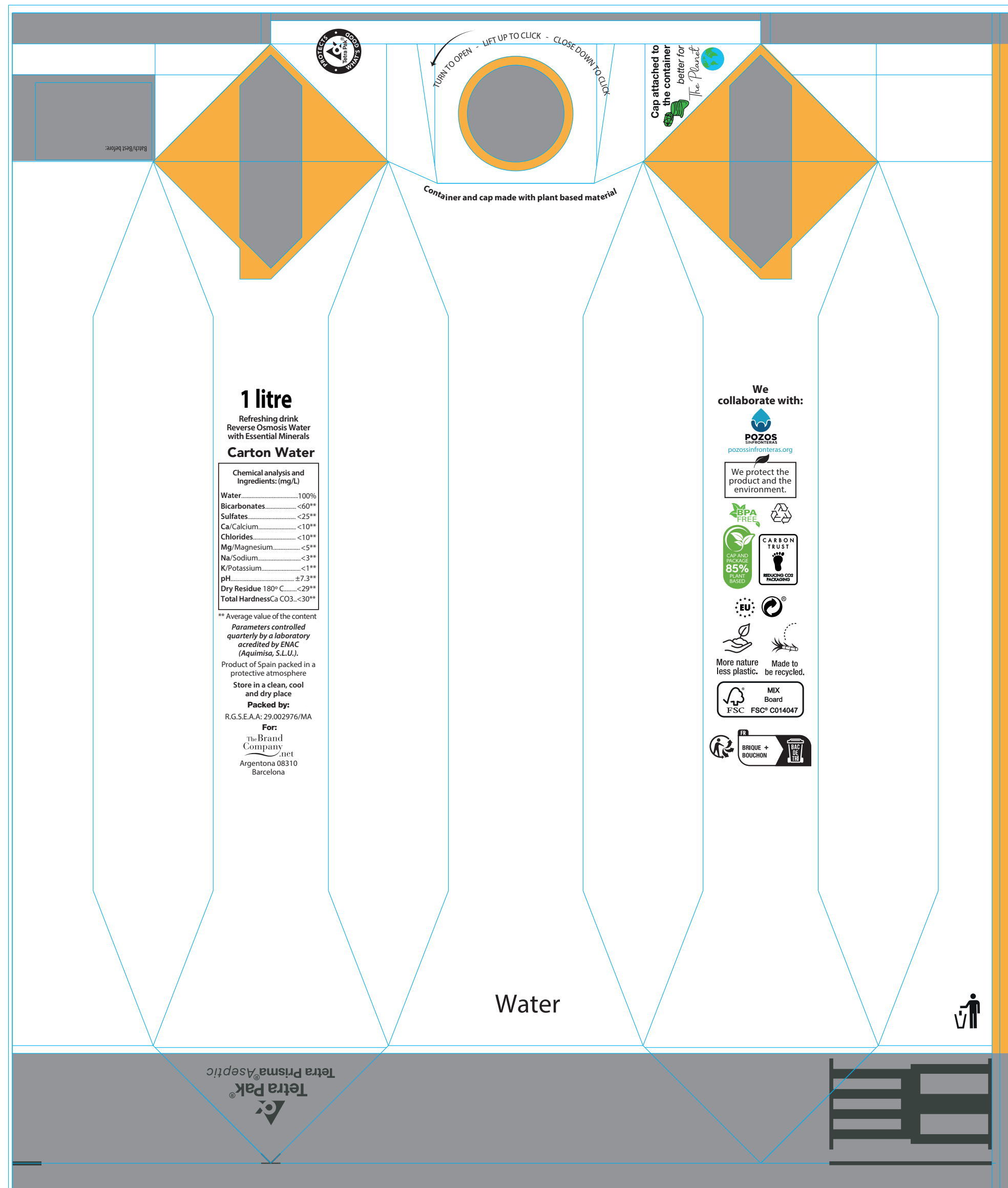

## REMEMBER:

We will need 2 design files:

1. Open with all the images in LAYER. Attach the FONTS that are used in development (All editable), that are used in development (All editable).
2. Another file, vectorized.
3. Please keep the "KEYLINES" LAYER how you receive it.
  - You can change the placement and color / size of the texts as long as they have a minimum size of 7pt.
  - If you are going to make a background with a photograph or a plot, the letters in white should have a frame or profile around. We can do that us for you.
  - The logos are optional (except the logos: recycled, FSC and tetra pack). They can be put in B / W or not.
  - The seal of collaboration with Pozos sin Fronteras (Wells without Borders) is optional.
  - You could add a phrase such as the one suggested here "We collaborate with" or add another of your choice.
4. Remove the Triman logo if you are not going to France